

Ventiladores centrífugos de alta presión para transporte de sólidos



CAST



Bancada soporte motor de alta robustez

Ventiladores centrífugos de alta presión y simple aspiración con envolvente y turbina de pala recta en chapa de acero, para transporte de polvo y material sólido.

Ventilador:

- Envolvente en chapa de acero
- Turbina de pala recta en chapa de acero

Motor:

- Motores clase F, con rodamientos a bolas, protección IP55
- Trifásicos 230/400V.-50Hz.(hasta 5,5CV.) y 400/690V.-50Hz.(potencias superiores a 5,5CV.)
- Temperatura máxima del aire a transportar: -20°C.+ 120°C

Acabado: Anticorrosivo en resina de poliéster, polimerizada a 190°C., previo desengrase alcalino y pretratamiento libre de fosfatos

Bajo demanda:

- Bobinados especiales para diferentes tensiones
- Ventilador preparado para transportar aire hasta 250°C
- Certificación ATEX Categoría 2

Características técnicas

Modelo	Velocidad (r/min)	Intensidad máxima admisible (A)			Potencia instalada (kW)	Caudal máximo (m3/h)	Nivel de presión sonora dB(A)	Peso Aprox. Kg.
		230V	400V	690V				
CAST-242-2T-0,5	2740	1,92	1,11		0,37	350	70	31,0
CAST-248-2T-1	2855	3,00	1,73		0,75	200	73	45,0
CAST-248-2T-1,5	2845	4,16	2,40		1,10	600	76	46,5
CAST-254-2T-1,5	2845	4,16	2,40		1,10	400	75	56,5
CAST-254-2T-2	2860	5,63	3,25		1,50	600	77	61,5
CAST-254-2T-3	2880	7,97	4,60		2,20	800	79	63,0
CAST-260-2T-2	2860	5,63	3,25		1,50	400	81	75,0
CAST-260-2T-3	2880	7,97	4,60		2,20	550	83	78,0
CAST-463-2T-5,5	2900	13,34	7,70		4,00	700	82	88,5
CAST-463-2T-7,5	2855		10,50	6,10	5,50	1460	83	95,5
CAST-467-2T-7,5	2855		10,50	6,10	5,50	1050	84	117,5
CAST-467-2T-10	2855		13,90	8,00	7,50	1840	85	122,5
CAST-571-2T-10	2855		13,90	8,00	7,50	1250	86	144,0
CAST-571-2T-15	2930		20,00	11,50	11,00	2700	87	175,0
CAST-640-2T-2	2860	5,63	3,25		1,50	1260	81	51,5
CAST-645-2T-3	2880	7,97	4,60		2,20	1400	82	62,5
CAST-645-2T-4	2895	10,57	6,10		3,00	2420	83	69,5
CAST-650-2T-5,5	2900	13,34	7,70		4,00	1700	84	89,0
CAST-650-2T-7,5	2855		10,50	6,10	5,50	3060	85	96,0
CAST-852-2T-7,5	2855		10,50	6,10	5,50	1800	87	96,0
CAST-852-2T-10	2855		13,90	8,00	7,50	3100	88	101,0
CAST-856-2T-15	2930		20,00	11,50	11,00	4800	85	157,5
CAST-863-2T-15	2930		20,00	11,50	11,00	2850	85	168,0
CAST-863-2T-20	2920		26,50	15,30	15,00	4500	86	179,0
CAST-971-2T-25	2920		32,00	18,50	18,50	2800	90	299,0
CAST-971-2T-30	2930		39,00	22,50	22,00	4000	91	324,0
CAST-971-2T-40	2955		53,00	30,60	30,00	7000	92	380,0
CAST-1250-2T-20/A	2920		26,50	15,30	15,00	8400	87	210,0
CAST-1456-2T-30/A	2930		39,00	22,50	22,00	10800	88	290,0
CAST-1663-2T-40/A	2955		53,00	30,60	30,00	12000	90	350,0



Dimensiones mm

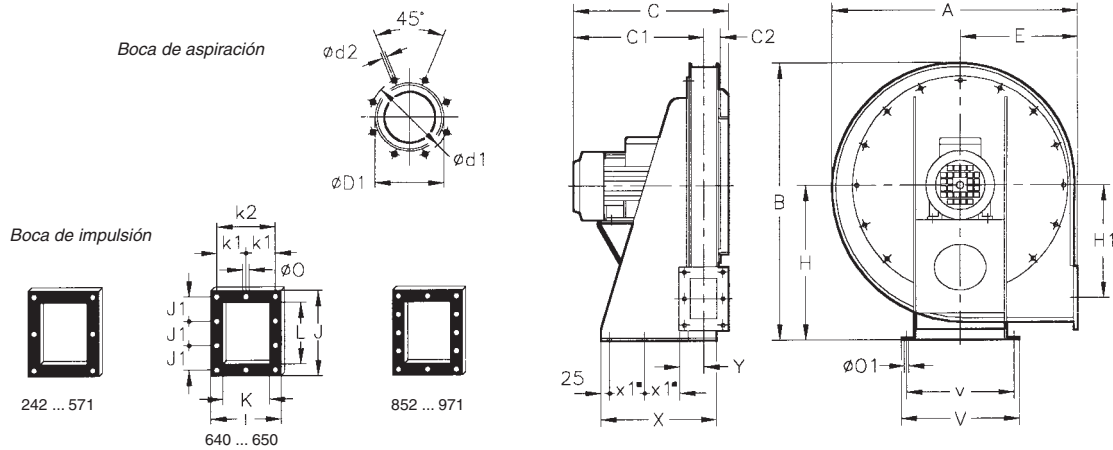

Modelo	A	B	C	C1	C2	ØD1*	Ød1	Ød2	E	H	H1	I	J	J1	K	k1	k2	L	Ø0	Ø01	V	v	X	x1	Y
CAST-242-2T-0,5	576	662	310	247	33	100	130	M.8	270	375	270	120	155	65	60	-	95	95	11	12	305	275	260	75	61
CAST-248-2T-1/1,5	639	728	340	274	36	112	140	M.8	300	410	297	126	165	70	66	-	101	105	11	12	320	290	300	90	64
CAST-254-2T-1,5	699	788	365	294,5	40,5	125	155	M.8	330	440	322	135	175	75	75	-	110	115	11	14	340	310	330	100	68,5
CAST-254-2T-2	699	788	413	342,5	40,5	125	155	M.8	330	440	322	135	175	75	75	-	110	115	11	14	340	310	330	100	68,5
CAST-254-2T-3	699	788	443	372,5	40,5	125	155	M.8	330	440	322	135	175	75	75	-	110	115	11	14	340	310	330	100	68,5
CAST-260-2T-2/3	782	875	419	343,5	47,5	150	175	M.8	370	485	362	145	185	80	85	-	120	125	11	14	380	350	370	115	73,5
CAST-463-2T-5,5	782	875	459	383,5	45,5	200	240	M.8	370	485	362	145	185	80	85	-	120	125	11	14	380	350	370	115	73,5
CAST-463-2T-7,5	782	875	517	441,5	45,5	200	240	M.8	370	485	362	145	185	80	85	-	120	125	11	14	380	350	370	115	73,5
CAST-467-2T-7,5/10	833	945	530	442	48	224	258	M.8	390	530	395	150	190	82,5	90	-	125	130	11	14	405	375	300	125	76
CAST-571-2T-10	873	995	536	445,5	50,5	250	275	M.8	410	560	410	155	205	90	95	-	130	145	11	14	430	400	350	150	79,5
CAST-571-2T-15	873	995	671	580,5	50,5	250	275	M.8	410	560	410	155	205	90	95	-	130	145	11	14	430	400	410	180	79,5
CAST-640-2T-2	639	728	446	350,5	65,5	250	275	M.8	300	410	250	185	260	78	125	80	-	200	11	14	340	310	350	100	93,5
CAST-645-2T-3	699	788	461	358	73	250	275	M.8	330	440	267,5	200	284	86	140	87,5	-	224	11	14	380	350	380	115	101
CAST-645-2T-4	699	788	491	388	73	250	275	M.8	330	440	267,5	200	284	86	140	87,5	-	224	11	14	380	350	380	115	101
CAST-650-2T-5,5	782	875	534	421	83	250	275	M.8	370	485	300	220	310	95	160	97,5	-	250	11	14	405	375	400	125	111
CAST-650-2T-7,5	782	875	572	459	83	250	275	M.8	370	485	300	220	310	95	160	97,5	-	250	11	14	405	375	400	125	111
CAST-852-2T-7,5/10	833	945	603	470	94,5	280	310	M.8	390	530	320	240	340	78	180	107,5	-	280	11	14	430	400	350	150	122
CAST-856-2T-15	833	945	708	575	93	355	395	M.8	390	530	320	240	340	78	180	107,5	-	280	11	14	430	400	410	180	122
CAST-863-2T-15/20	873	995	728	585	103	355	410	M.8	410	560	325	260	375	87,5	200	117,5	-	315	11	14	430	400	410	180	132
CAST-971-2T-25	1012	1170	759	598	116	400	450	M.10	460	670	420	294	425	100	224	132	-	355	11	14	550	510	500	150	145
CAST-971-2T-30	1012	1170	881	720	116	400	450	M.10	460	670	420	294	425	100	224	132	-	355	11	14	550	510	500	150	145
CAST-971-2T-40	1012	1170	948	787	116	400	450	M.10	460	670	420	294	425	100	224	132	-	355	11	14	550	510	500	150	145

*Diámetro nominal tubería recomendada.

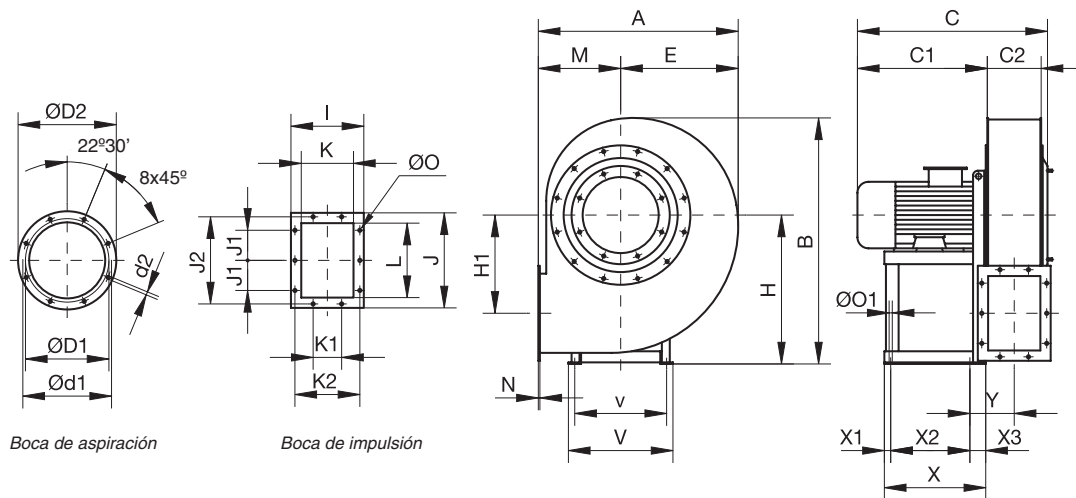

Modelo	A	B	C	C1	C2	ØD1*	ØD2	Ød1	d2	E	H	H1	I	J	J1	J2	K	K1	K2	L	M	N	Ø0	Ø01	V	v	X	X1	X2	X3	Y
CAST-1250-2T-20/A	850	1040	790	543	230	315	401	366	M8	495	630	407	304	395	125	366	224	125	273	315	355	5	11,5	14	440	400	425	30	340	55	174
CAST-1456-2T-30/A	955	1165	806	542	256	355	441	405	M8	555	710	458	330	435	125	405	250	125	300	355	400	5	11,5	14	500	450	470	35	370	65	197
CAST-1663-2T-40/A	955	1170	881	617	256	355	441	405	M8	555	710	458	330	435	125	405	250	125	300	355	400	5	11,5	16	570	510	500	40	385	75	207

*Diámetro nominal tubería recomendada.



Orientaciones

Suministro standard LG 270. Posición LG180 bajo demanda y con medidas de anclajes especiales.

Suministro bajo demanda. Posición RD180 con medidas de anclajes especiales.

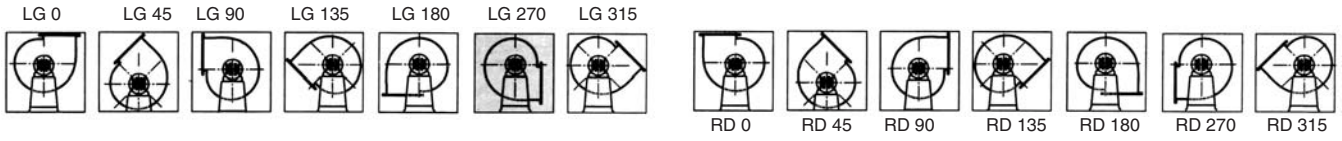

Curvas Características

Q = Caudal en m³/h y m³/s.

Pe = Presión estática en mm.c.a. y Pa.

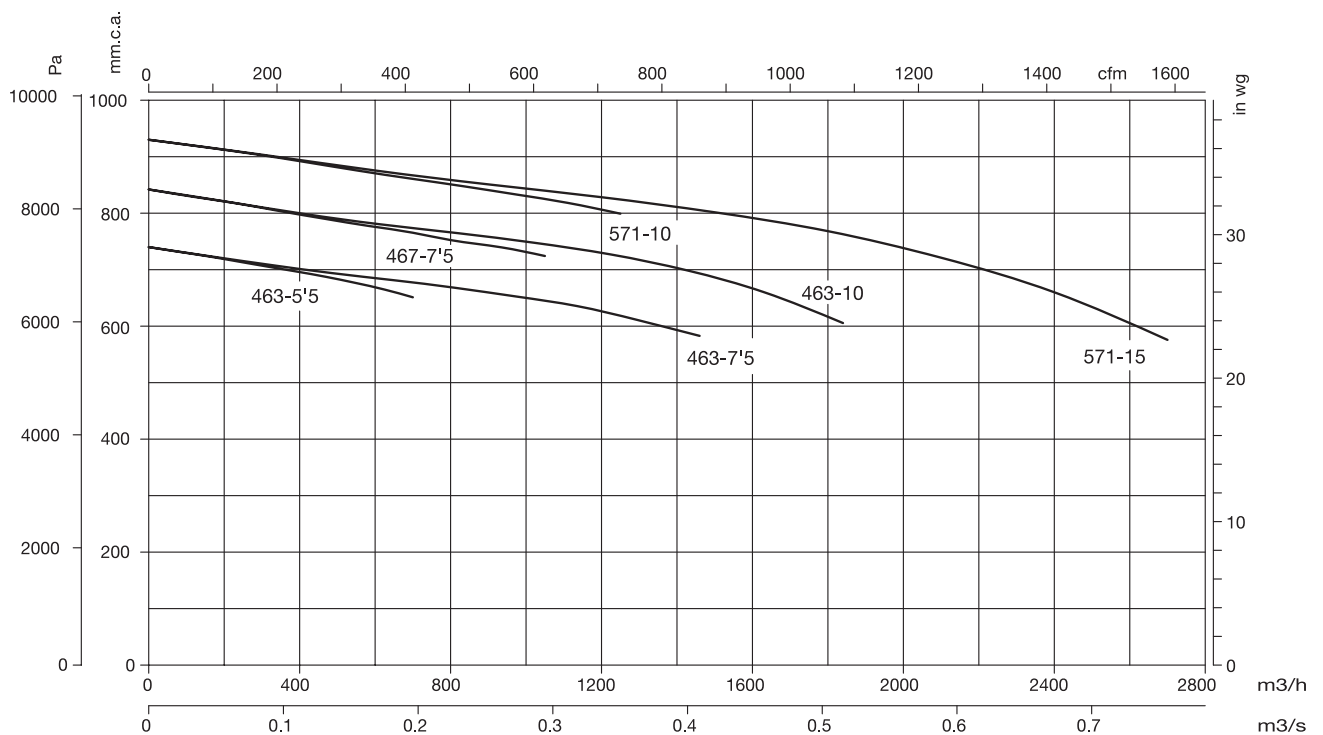
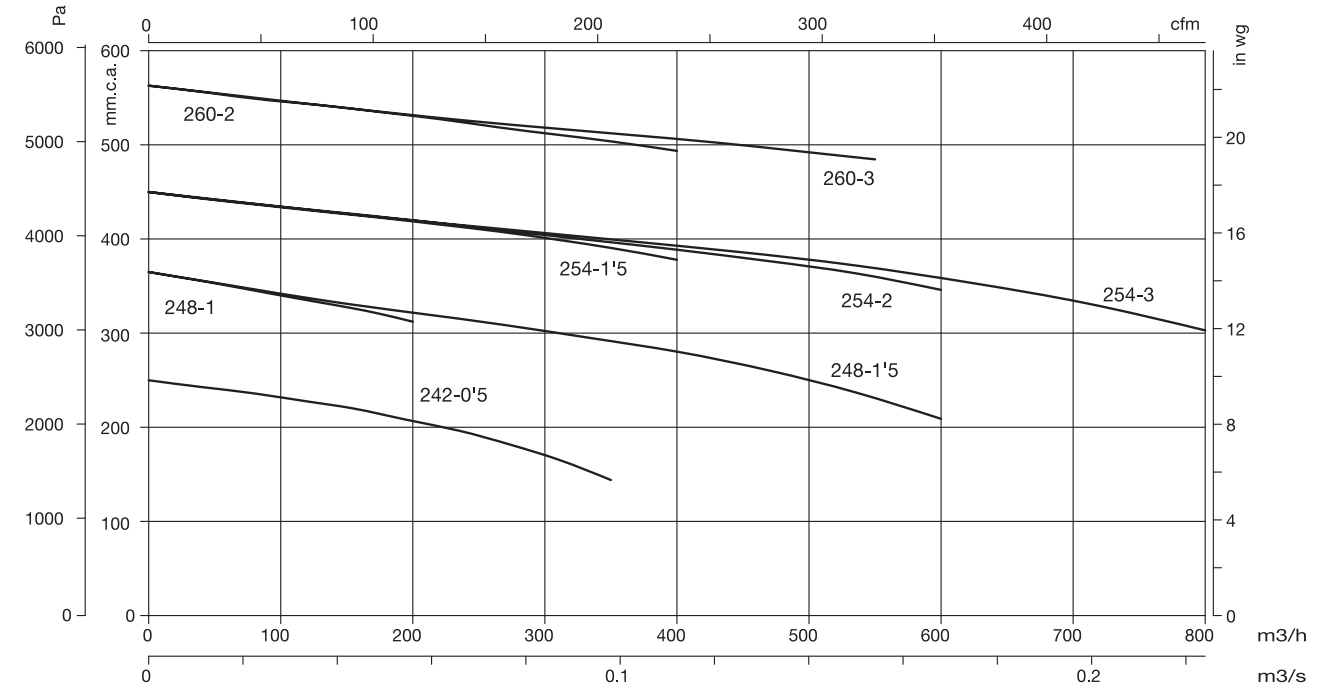



Curvas Características

Q = Caudal en m³/h y m³/s.

Pe = Presión estática en mm.c.a. y Pa.

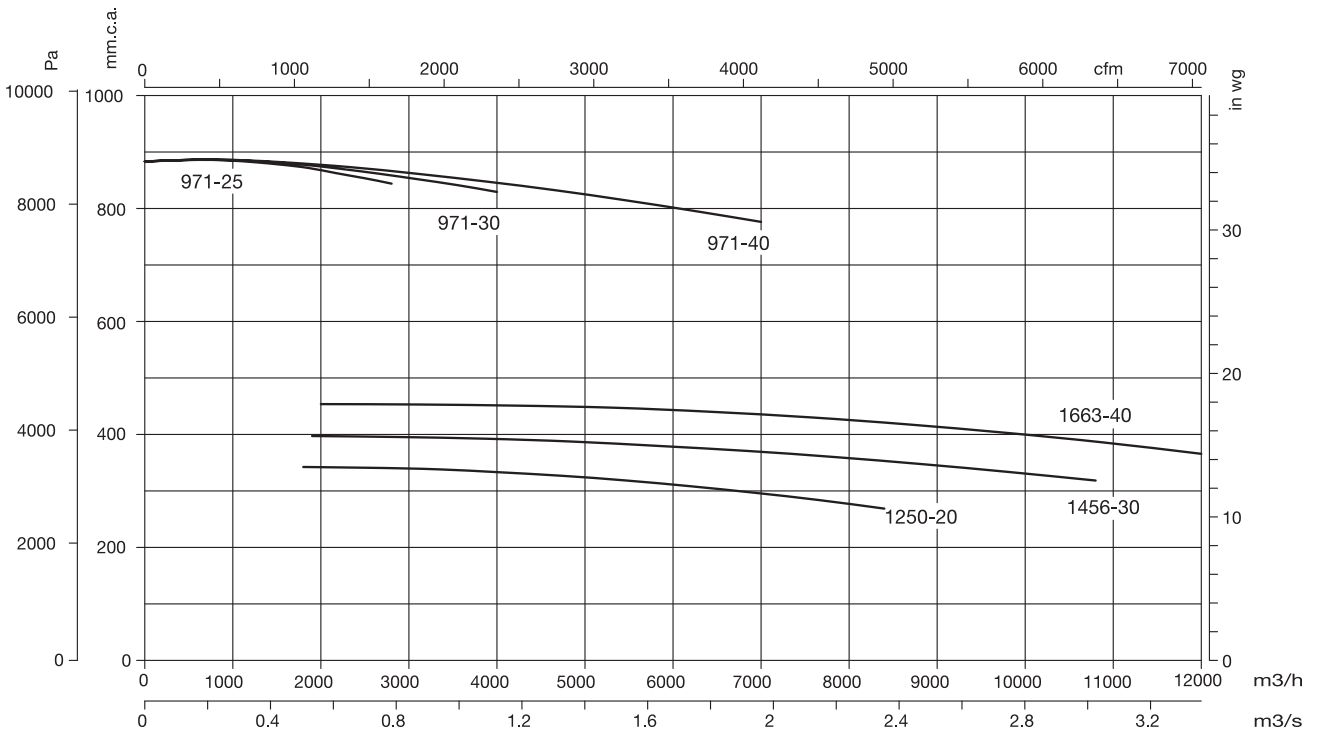
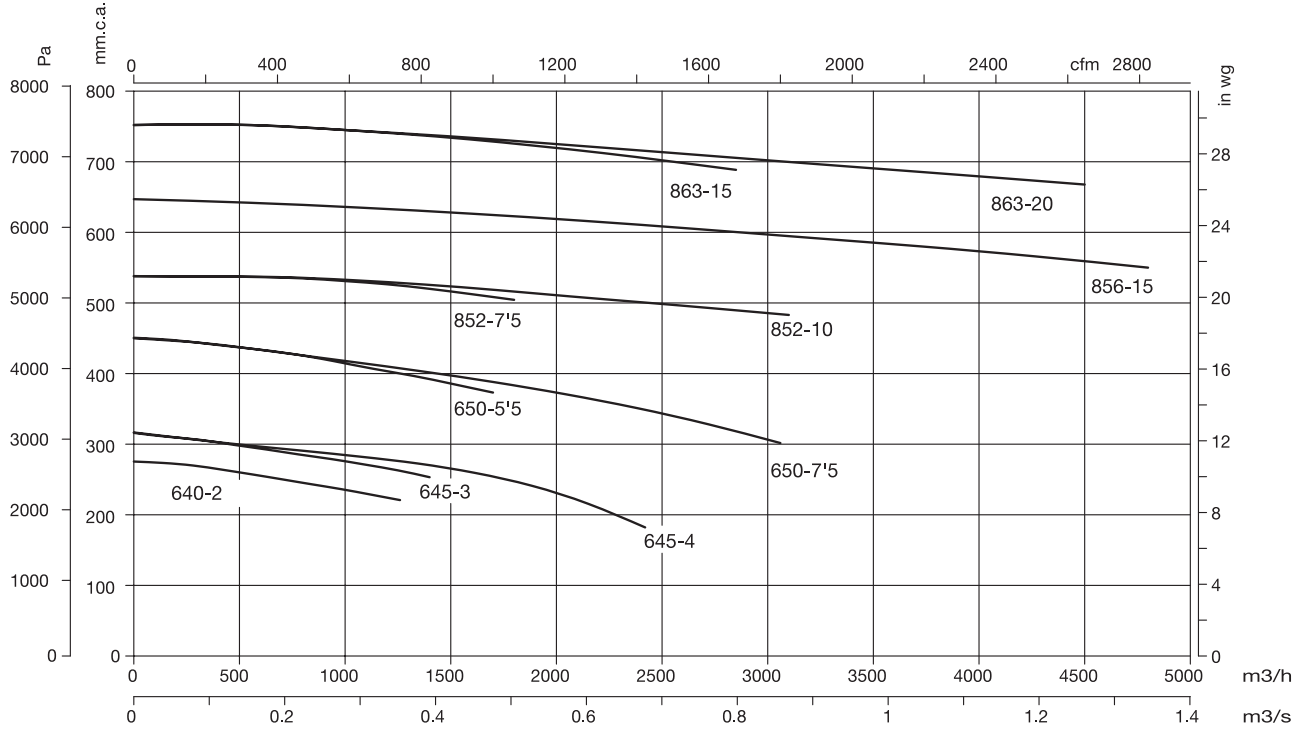

Accesorios

Ver apartado accesorios.

