

Ventiladores centrífugos anticorrosivos en material plástico



CPV



Estético y moderno diseño

Ventiladores centrífugos de simple aspiración fabricados en polipropileno.

Ventilador:

- Envoltente en polipropileno
- Turbina con álabes hacia delante, en polipropileno

Motor:

- Motores clase F, con rodamientos a bolas, protección IP55
- Trifásicos 230/400V.-50Hz.(hasta 5,5CV.) y 400/690V.-50Hz.(potencias superiores a 5,5CV.)
- Temperatura máxima del aire a transportar : -20°C.+ 50°C.

Acabado: Anticorrosivo en material plástico

Bajo demanda:

- Bobinados especiales para diferentes tensiones
- Certificación ATEX Categoría 3

Características técnicas

Modelo	Velocidad (r/min)	Intensidad máxima admisible (A)			Potencia instalada (kW)	Caudal máximo (m3/h)	Nivel de presión sonora dB(A)	Peso Aprox. Kg.
		230V	400V	690V				
CPV-815-2T	2810	1,73	1,00		0,37	950	75	14,0
CPV-815-4T	1360	1,32	0,76		0,25	450	58	14,0
CPV-1020-2T	2800	3,00	1,73		0,75	2000	81	19,5
CPV-1020-4T	1360	1,32	0,76		0,25	1250	65	19,5
CPV-1020-6T	880	1,67	0,96		0,25	750	53	19,5
CPV-1325-2T	2850	7,97	4,60		2,20	3250	87	27,0
CPV-1325-4T	1360	1,78	1,03		0,37	2300	69	27,0
CPV-1325-6T	880	1,67	0,96		0,25	1400	59	27,0
CPV-1630-4T	1420	5,98	3,45		1,50	4500	75	34,5
CPV-1630-6T	910	2,80	1,61		0,55	2700	63	34,5
CPV-1840-4T	1420	11,09	6,40		3,00	6000	70	48,0
CPV-1840-6T	900	5,04	2,90		1,10	4200	65	42,0
* CPV-1942-4T-7,5	1450		11,40	6,60	5,50	8500	79	66,0
* CPV-1942-4T-10	1450		15,10	8,70	7,50	10500	84	77,0
* CPV-1942-6T	930	9,32	5,36		2,20	7000	75	49,0
* CPV-1942-8T	710	7,10	4,08		1,50	5500	70	56,0
CPV-2045-4T	1450		15,10	8,70	7,50	10400	78	102,0
CPV-2045-6T	950	12,20	7,00		3,00	7000	72	88,0
CPV-1030-2T	2900	19,23	11,10		4,00	2900	75	66,0
CPV-1335-2T	2915		14,70	8,50	5,50	4700	84	91,0
CPV-1160-4T	1460		21,50	12,40	11,00	8000	83	243,0
CPV-2060-4T	1460		21,50	12,40	11,00	12000	81	245,0
CPV-2160-4T	1455		28,50	16,50	15,00	15500	77	282,0
* CPV-720-2T	2840	1,82	1,05		0,37	525	75	10,0
* CPV-825-2T	2850	4,33	2,50		1,10	1140	79	17,0
* CPV-930-2T	2880	7,57	4,37		2,20	1750	84	24,0

* Solo admiten orientación LG



Características acústicas

Los valores indicados, se determinan mediante medidas de nivel de presión y potencia sonora en dB(A) obtenidas en campo libre a una distancia equivalente a dos veces la envergadura del ventilador más el diámetro de la turbina, con un mínimo de 1,5 mts.

Espectro de potencia sonora Lw(A) en dB(A) por banda de frecuencia en Hz.

Modelo	63	125	250	500	1000	2000	4000	8000	Modelo	63	125	250	500	1000	2000	4000	8000
815-2	56	69	77	81	81	77	73	65	1942-4-10	80	90	92	95	94	94	92	83
815-4	39	52	60	64	64	60	56	48	1942-6	71	81	83	86	85	85	83	74
1020-2	62	75	83	87	87	83	79	71	1942-8	66	76	78	81	80	80	78	69
1020-4	46	59	67	71	71	67	63	55	2045-4	63	76	84	88	89	85	81	72
1020-6	34	47	55	59	59	55	51	43	2045-6	57	70	78	82	83	79	75	66
1325-2	70	83	91	95	96	92	88	79	1030	58	71	79	83	84	80	76	67
1325-4	52	65	73	77	78	74	70	61	1335	67	80	88	92	93	89	85	76
1325-6	42	55	63	67	68	64	60	51	1160	68	81	89	93	94	90	86	77
1630-4	60	73	81	85	86	82	78	69	2060	66	79	87	91	92	88	84	75
1630-6	48	61	69	73	74	70	66	57	2160	64	77	85	89	89	85	81	73
1840-4	55	68	76	80	81	77	73	64	720	56	69	77	81	81	77	73	65
1840-6	50	63	71	75	76	72	68	59	825	60	73	81	85	85	81	77	69
1942-4-7,5	75	85	87	90	89	89	87	78	930	65	78	86	90	90	86	82	74

Dimensiones mm

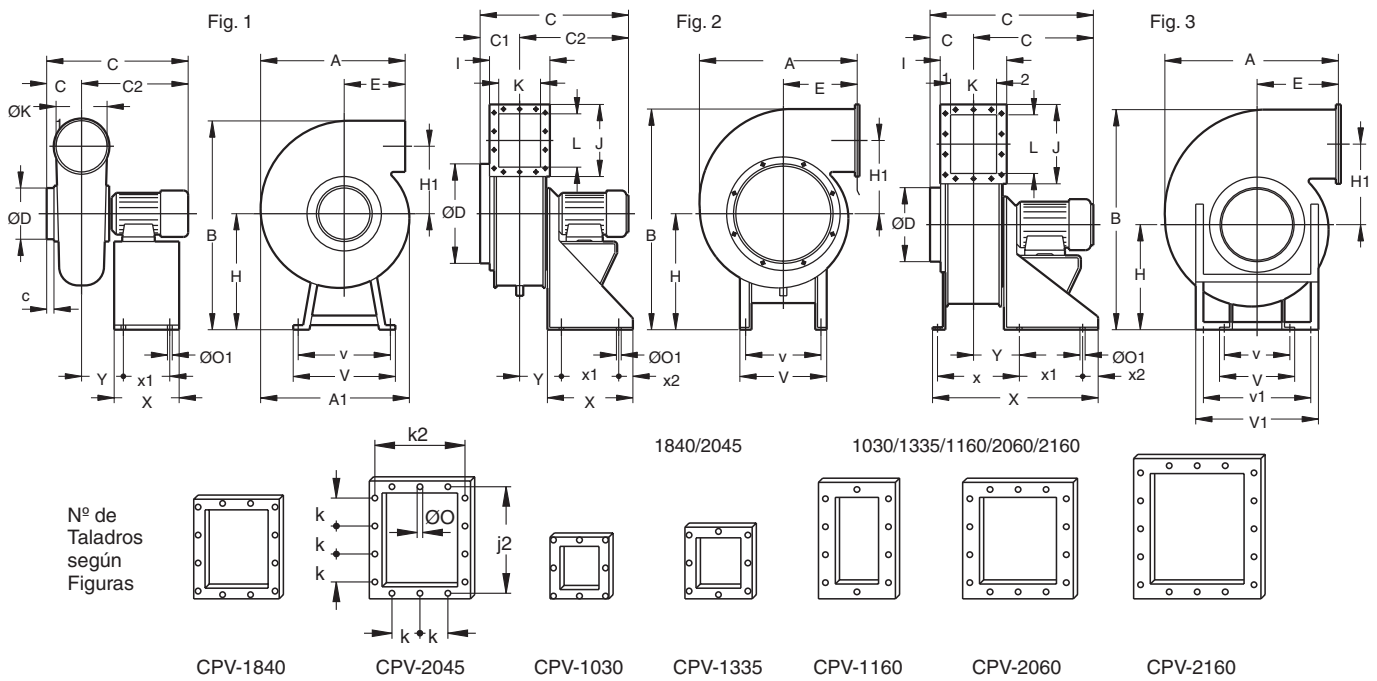

Modelo	Fig.	A	A1	B	C	C1	C2	c	ØD	E	H	H1	I	J	J2	K	k	k2	L	ØØ	ØØ1	V	V1	v	v1	X	x	x1	x2	Y
CPV-815	1	303	335	521	371	100	271	30	125	100	281	177,5	-	-	-	125	-	-	-	-	8	355	-	335	-	180	-	160	-	90
CPV-1020-2T	1	340	397	584	440	116	324	32	160	100	281	223	-	-	-	160	-	-	-	-	8	355	-	335	-	180	-	160	-	121
CPV-1020	1	340	397	584	413	116	297	32	160	100	281	223	-	-	-	160	-	-	-	-	8	355	-	335	-	180	-	160	-	116
CPV-1325-2T	1	413	505	735	487	130	357	35	200	103	370	265	-	-	-	200	-	-	-	-	8	400	-	380	-	180	-	160	-	126
CPV-1325	1	413	505	716	438	130	308	35	200	103	351	265	-	-	-	200	-	-	-	-	8	400	-	380	-	180	-	160	-	127
CPV-1630-4T	1	490	602	888	529	145	384	35	250	117	440	323	-	-	-	250	-	-	-	-	8	450	-	430	-	240	-	220	-	143
CPV-1630-6T	1	490	602	878	495	145	350	35	250	117	430	323	-	-	-	250	-	-	-	-	8	450	-	430	-	240	-	220	-	137
CPV-1840-4T	2	631	-	819	660	210	450	-	355	275	420	259	305	356	326	225	100	275	280	9	12	320	-	285	-	300	-	200	50	170
CPV-1840-6T	2	631	-	819	660	210	450	-	355	275	410	259	305	356	326	225	100	275	280	9	12	320	-	285	-	300	-	200	50	170
CPV-1942-4T	1	580	750	1170	792	210	642	60	315	130	600	412,5	-	-	-	315	-	-	-	-	8	600	-	564	-	350	-	314	-	188
CPV-1942-6T	1	580	750	1150	724	210	574	60	315	130	580	412,5	-	-	-	315	-	-	-	-	8	600	-	564	-	350	-	314	-	188
CPV-1942-8T	1	580	750	1150	724	210	574	60	315	130	580	412,5	-	-	-	315	-	-	-	-	8	600	-	564	-	350	-	314	-	188
CPV-2045	2	736	-	1020	810	245	565	-	400	310	542	310	362	421	381	270	100	322	335	9	12	350	-	315	-	350	-	250	50	195
CPV-1030	3	494	-	698	-	155	-	-	200	225	410	210,5	210	221	200	140	100	186	155	9	12	260	-	234	-	-	-	175	50	130
CPV-1335	3	566	-	788	-	175	-	-	225	255	452	246	240	256	226	160	100	210	180	9	12	320	-	285	-	-	-	200	50	140
CPV-1160	3	937	-	1276	-	210	-	-	350	410	700	421	275	416	366	155	100	225	310	9	14	500	790	450	670	710	265	360	60	155
CPV-2060	3	937	-	1276	-	270	-	-	400	410	700	421	395	416	366	275	100	345	310	9	14	500	790	450	670	830	385	360	60	215
CPV-2160	3	981	-	1336	-	285	-	-	600	414	700	438,5	455	501	451	335	100	405	395	9	14	500	790	450	670	890	445	360	60	240
CPV-720	1	375	-	456	350	80	270	45	90	212	281	130	-	-	-	90	-	-	-	-	8	355	-	355	-	180	-	160	-	92
CPV-825	1	445	-	522	433	110	323	55	125	218	290	170	-	-	-	125	-	-	-	-	8	355	-	335	-	180	-	160	-	103
CPV-930	1	540	-	658	477	100	377	40	160	262	370	205	-	-	-	160	-	-	-	-	8	400	-	380	-	180	-	160	-	117



Orientaciones

Suministro standard LG 90

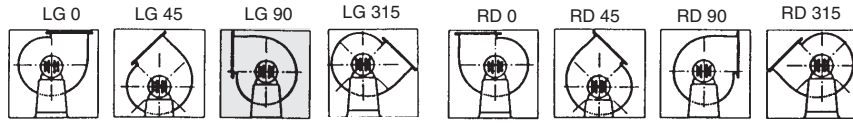

Curvas Características

Q = Caudal en m³/h y m³/s.

Pe = Presión estática en mm.c.a. y Pa.

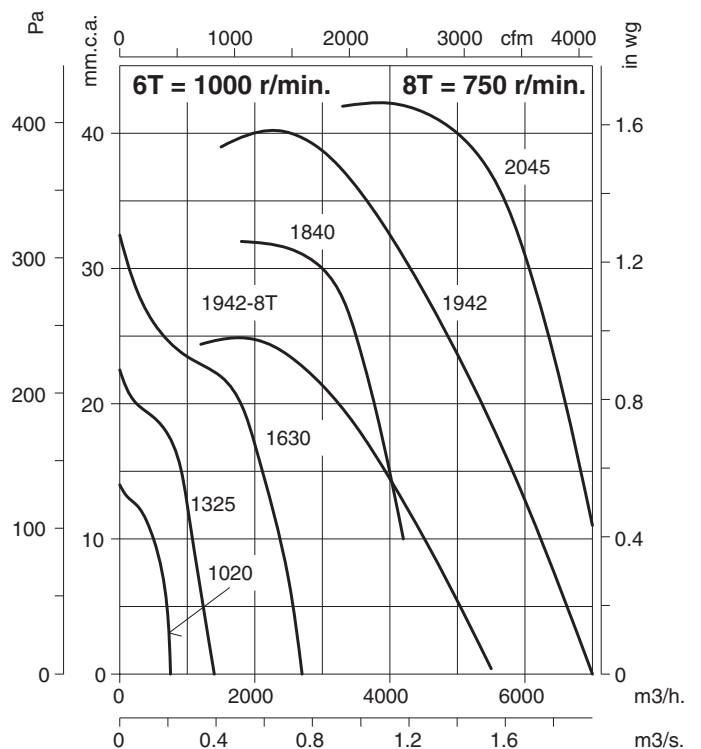
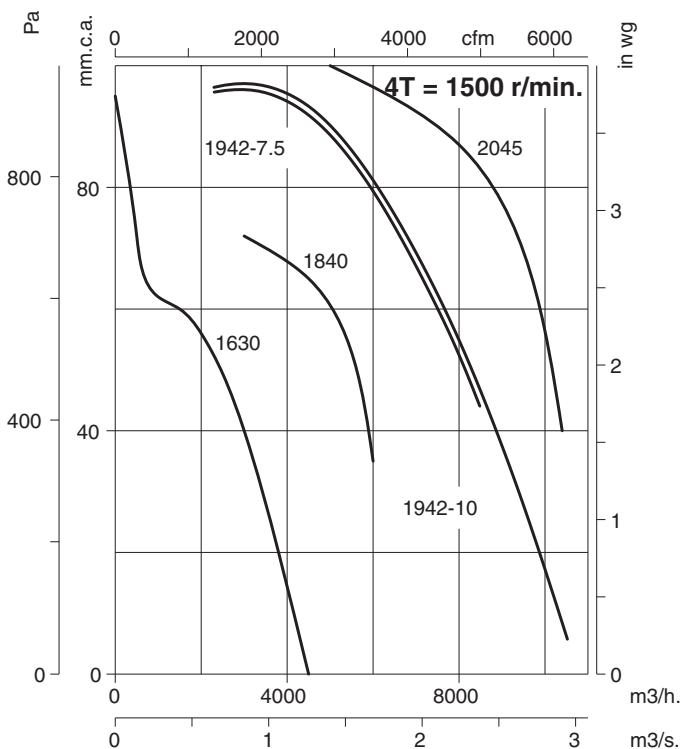
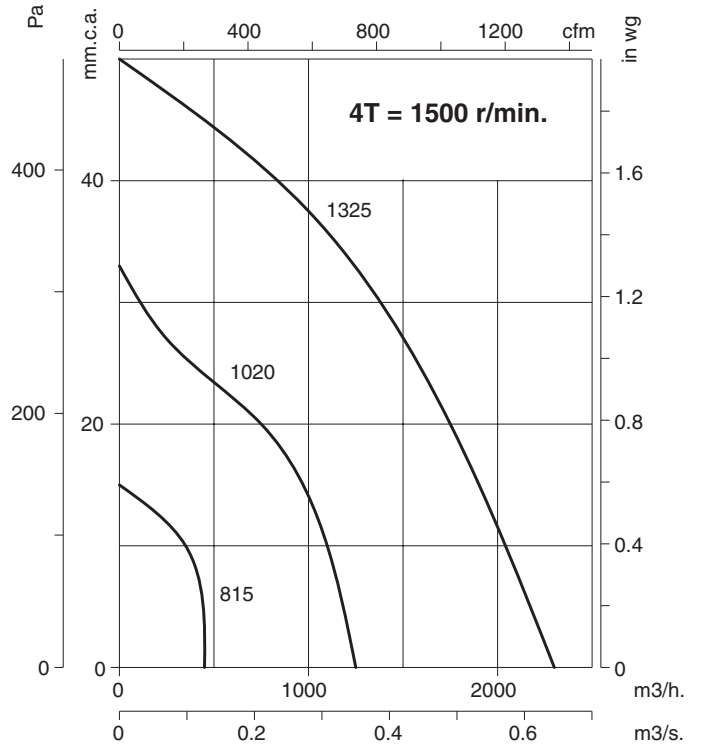
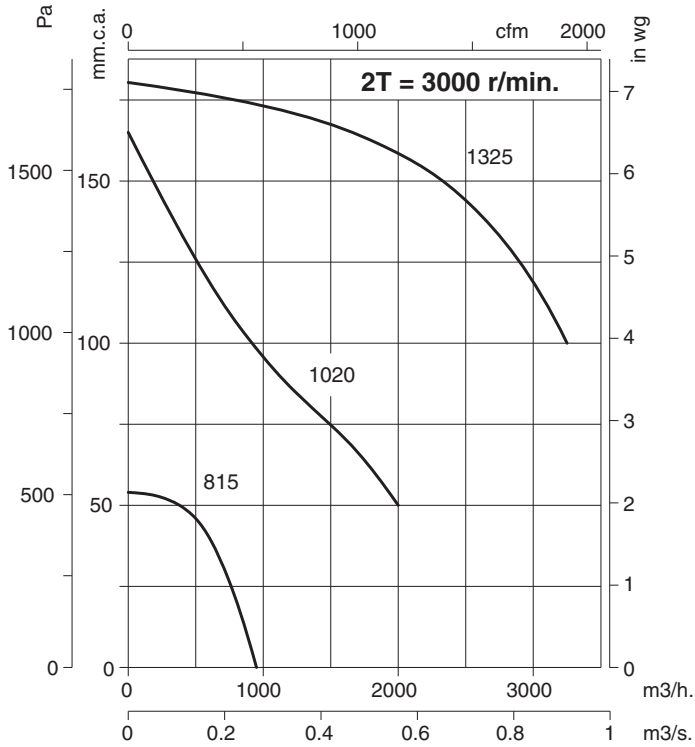



Curvas Características Q = Caudal en m³/h y m³/s. Pe = Presión estática en mm.c.a. y Pa.

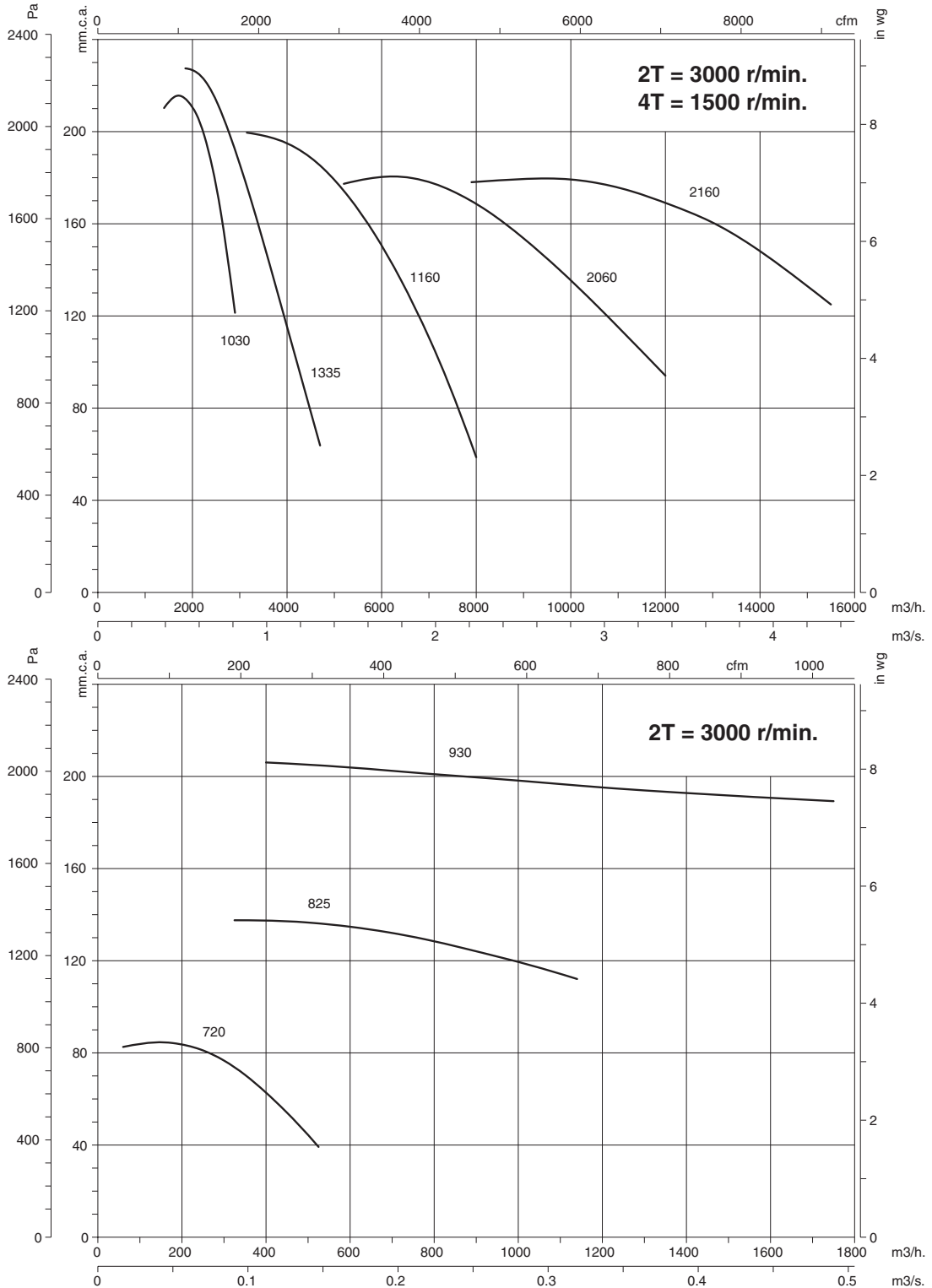

Accesorios

Ver apartado accesorios.



INT



RFT



BIC